

FLEX-SYMES™



Extremely low build height with a Carbon-X® Active Heel and alignment options.

The Flex-Symes foot design is a carbon foot module connected to an actively deflecting carbon heel. The improved alignment adapter now offers angulation and adjustments in ML / AP planes.

Flex-Symes is specifically designed for people with symes and pyroff amputations or transtibial users with long residual limbs.



User Information	
Amputation Level:	Ankle Disarticulation
Impact Level:	Low to High
Maximum Patient Weight:	166kg (365lbs)

Foot Information	
Categories:	Size 22-24; Cat. 1-6 / Size 27-30; Cat. 1-9
Sizes:	22-30
Weight of Foot: (Size 27)	528 g (18.6 oz) w/ Foot Cover
Build Height: (Size 27)	60mm (2 3/8") w/ Foot Cover
Heel Height:	10mm (3/8")
Adapter Options:	Direct Lamination Adapter



PROPORTIONAL RESPONSE



CARBON-X® ACTIVE HEEL



FULL LENGTH TOE LEVER



SPLIT TOE



WATERPROOF

ORDERING INFORMATION

FOR COMPLETE FOOT WITH SOCKET ADAPTER

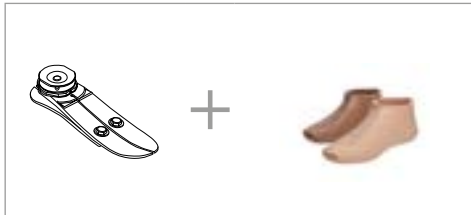

FOR COMPLETE FOOT WITHOUT ADAPTER



CATEGORY SELECTION CHART

Weight kg	45-52	53-59	60-68	69-77	78-88	89-100	101-116	117-130	131-147	148-166
Weight lbs	97-115	116-130	131-150	151-170	171-194	195-220	221-256	257-287	288-324	325-356
Low Impact Level	1	1	2	3	4	5	6	7	8	9
Moderate Impact Level	1	2	3	4	5	6	7	8	9	N/A
High Impact Level	2	3	4	5	6	7	8	9	N/A	N/A

FLEX-SYMES™

CLEARANCE

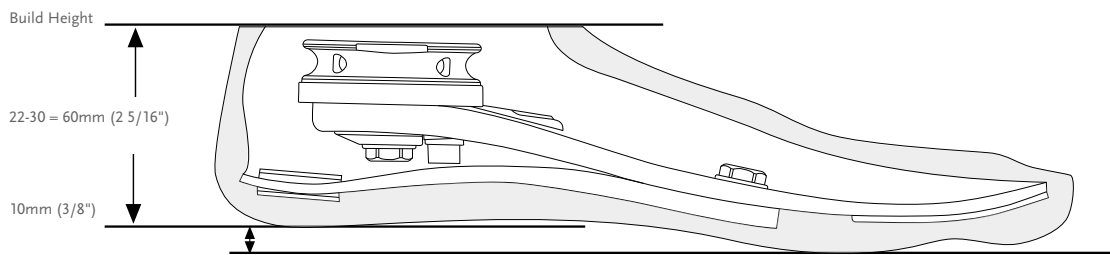

KITS

FLEX-SYMES WITH SOCKET ADAPTER

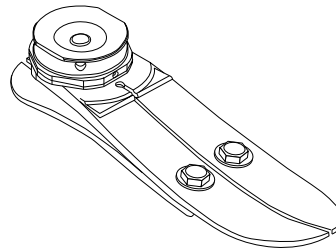
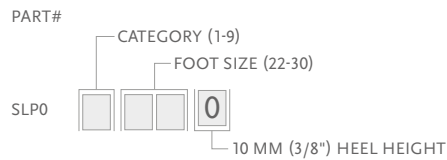

Includes:

- Carbon foot module with heel
- 2 Circular alignment wedges
- 2 Alignment pins
- 1 Anti-rotation bolt
- Washer
- Loctite 410
- Epoxy potting
- Socket adapter

FLEX-SYMES WITHOUT ADAPTER

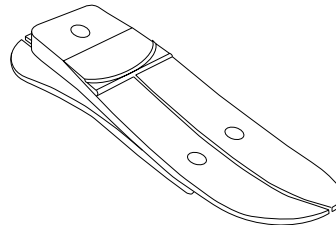
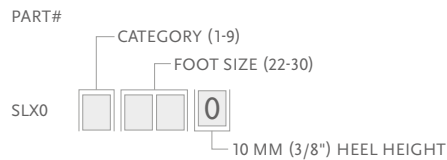

Includes:

- Carbon foot module with heel
- 2 Circular alignment wedges
- 2 Alignment pins
- 1 Anti-rotation bolt
- Washer
- Loctite 410
- Epoxy potting

Note: Solid toe is a special order.

COMPONENTS

HEEL MODULE

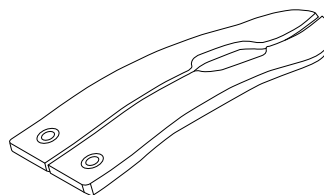
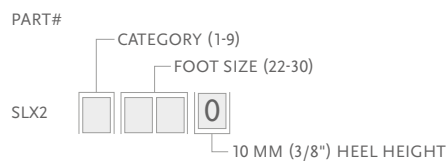

FLEX-SYMES™

COMPONENTS

ALIGNMENT DISC KIT

Part#	Foot Size	Cat.
SLP30001	22-24	1-6
SLP30002	25-27	1-6
SLP30003	28-30	1-6
SLP30004	25-27	7-9
SLP30005	28-30	7-9

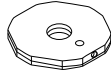

Includes:

- 2 Circular alignment wedges
- 2 Alignment pins
- 1 Anti rotation bolt
- Washer
- Loctite 410

LAMINATION KIT

Part#	Foot Size	Cat.
SLP30011	22-24	1-6
SLP30012	25-27	1-6
SLP30013	28-30	1-6
SLP30014	25-27	7-9
SLP30015	28-30	7-9

Includes:

- Socket adapter with insert
- Epoxy potting

SOCKET ADAPTER WITH INSERT

Part#	Cat.	Foot Size
SLX50001	1-6	22-24
SLX50002	1-6	25-27
SLX50003	1-6	28-30
SLX50004	7-9	25-27
SLX50005	7-9	28-30

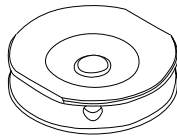

HEEL FASTENER HARDWARE KIT

Part#	Length	Size	Cat.
CM150004	18mm	11/16" 6mm 1/4"	1-6
CM150005	18mm	11/16" 8mm 5/16"	7-9

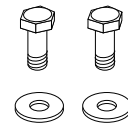

Includes:

- Bolt
- Washer

CENTRAL BOLTS

Part#	Foot Size	Bolt Size	Cat.
SLX30021	22-27	M12	1-6
SLX30022	25-27	M14	7-9
SLX30022	28-30	M14	1-6
SLX30023	28-30	M16	7-9

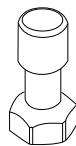

ANTI-ROTATION BOLT KIT

Part#	Foot Size	Bolt Size
SLX30005	22-27	M6
SLX30007	28-30	M8

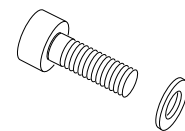

Includes:

- Bolt
- Washer

HEEL WEDGE KIT

Part#	Foot Size	Cat.
CM150011	22-30	1-9



Includes:

- 3 Wedges
- Adhesive

Picture	Part#	Description
1.	SLX30006	Alignment Pin
2.	CM140003	Heel Divider
	CM160009	Potting Epoxy

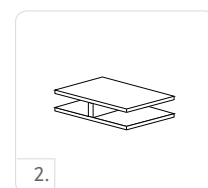
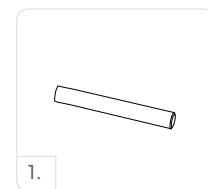

FLEX-SYMES™

COSMETIC FINISHING

FOOT COVER KIT, BEIGE AND BROWN*

PART#

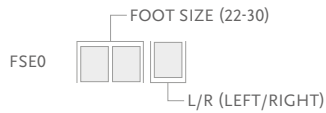

Includes:

- Foot Cover*
- Attachment Plate
- Flex Foot Sock

*Please specify when ordering brown covers add "BR" to the part#.

FLEX-FOOT SOCKS

Used to cover the composite foot module to protect the foot and eliminate noise between foot module and foot shell.

Part#	Description	Size	Color
FSEL60001	Black Sock Small 1 pc	22-25	Black
FSEL60002	Black Sock Large 1 pc	26-30	Black
FSEL60001-15	Black Sock Small 15 pc	22-25	Black
FSEL60002-15	Black Sock Large 15 pc	26-30	Black



DIAGRAM

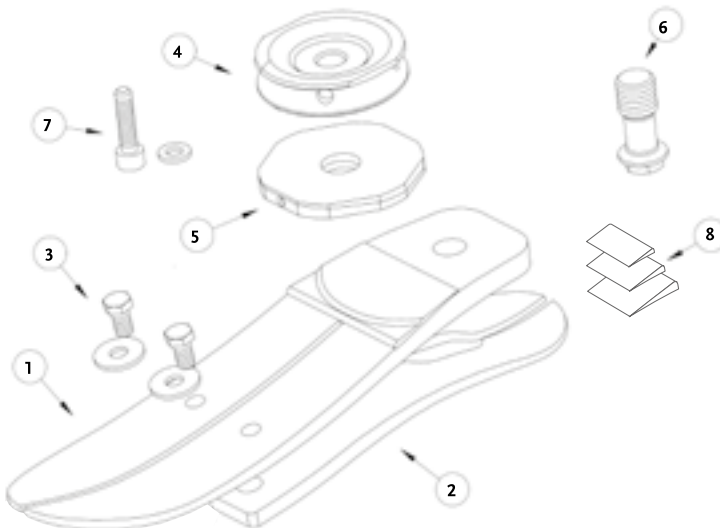

	Description		Description
1.	Foot Module	5.	Alignment Disc Kit
2.	Heel	6.	Central Bolt
3.	Heel Fastener Hardware Kit	7.	Anti-Rotation Bolt Kit
4.	Socket Adapter	8.	Heel Wedge Kit